



<b>PHILOSOPHY</b>	01 - 02
<b>BAG</b>	
humble bag	04
x bag	05 - 08
wise bag	09 - 12
inner case L	10
<b>MONEY STUFF</b>	
wallet #1, #2	13
fold wallet M#3, S#3	13
passport wallet S#1	13
money clip #1, #2 #3	14
PUBB collection	14
zipper wallet L, M, S	16
<b>TRAVEL STUFF</b>	
travel wallet M, S	17
luggage tag L, M	17
passport case M#2, M#3	18
passport case S#2	18
walker camera strap collection	20
<b>SOFTCASE</b>	
laptop case 15", 13"	21
laptop softcase 15"#3, 13"#3, 12"#3	23
document softcase M#3, S#3	24
ipad softcase	24
ipad mini softcase	24
<b>SNAP COLLECTION</b>	26
<b>CARD CASE</b>	
card sleeve	27
card wallet	27
card case #1, #2	27
card case + strap	28
card holder #1, #2, #3	28
bank passbook case #2	29
card holder M#2, S#2	29
<b>CREATIVE DESKTOP</b>	
key jacket #3, #4	30
key and card case #2	30
keyring, keyring L, cable keyring	30
phone case L#4, M#4, S#4	31
phone wallet L#1, M#1	31
pen case #1, L#2, M#2, S#2	32
pocket #1, #2	32
cable clip #1, #2	33
double cable clip	33
earphones clip	33
stitch case M, S	34
pen holder band	34
handy book M, S	34
<b>ORGANIZER</b>	
organizer #3, #5, #6, #7	35
refill paper	36
<b>ARCHITECT BLACK</b>	37 - 40

\* WE RECOMMEND OUR PRODUCT IN THIS CATALOG



This catalog is printed with eco-friendly process and material. We use Green ocean paper and soy ink. This process reduces Co<sub>2</sub> emission, equal to absorption process of 58 trees for 1 year.





### Labrador's story begins...

At Labrador, we believe in free and independent thinking without limitations. The young and energetic minds of our creative designers enable us to create attractive products with simplicity and minimalism design concepts. Above all, we create our products with love so that our customers have a deep connection with the products.

All our products are handmade and have a bold and unique character of design. This product design concept has seen our popularity soaring in international markets. We have established our products worldwide and have received excellent feedback from our customers especially for our products' minimalism, durability and life long attractiveness.

### environmental products?

Nowadays the world are persuaded by cheap and low quality product. With unintentional or being blind, the low quality product and low quality material ruin the world by waste. Low quality product will easily broken or be damaged. So the cost of recycling is maybe more than the price of the product. Is it worth to buy if the product that harm our world eventually? If everyone know this environmental concern, they can help the world by reducing trash.

We believe in using the high quality of raw materials to make our beautiful products. This ensures a very high durability of our product range. It also ensures that the waste is easily recyclable. Like our products, we love our environment and ensure that all our products are eco friendly and waste is minimized and easily recyclable. This is our commitment to make our world a better place.



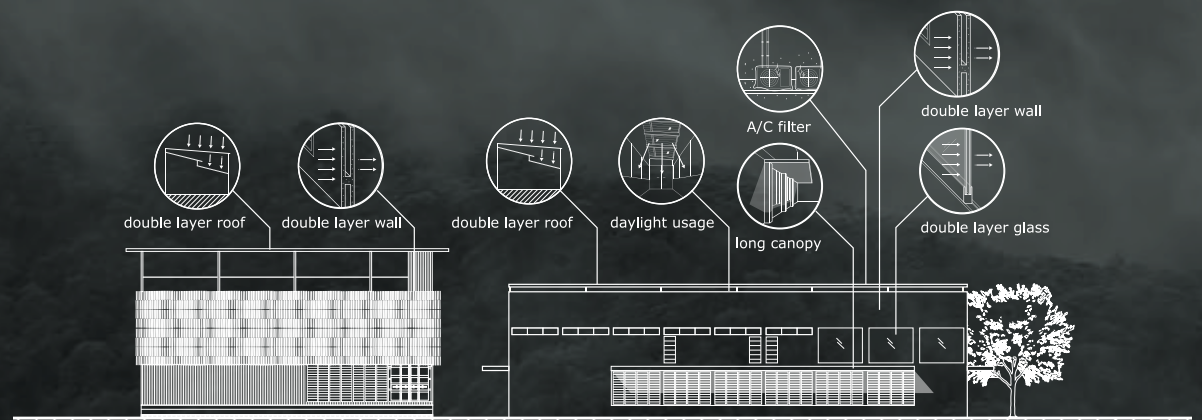

### [ high quality product = waste reduction ]



### eco, life, design, product, our work...

Our designs and products are meant to serve you forever. Unlike fashion products, our design concept of minimalism and high quality. This improves the natural touch and feel of the product and enhances its life. The low waste design process minimizes natural resource consumption and maximizes natural beauty of leather.

Our factory is also designed on the principles of eco friendliness. It has a unique natural light usage design, a water treatment system, a natural ventilation system and low heat transmissibility. This ensures that our people have a comfortable space to work. Absolutely the recycle process is applied as well.

-  recyclable material
-  local material
-  low energy consumption
-  low waste

### labrador and award

labrador was awarded three prizes by Prime Minister's Export Award

- 1) BEST DESIGN 2009
- 2) BEST GREEN INNOVATION 2014
- 3) BEST THAI BRAND 2017

Prime Minister's Export Award is a prize for success. The highest for both operators and services. This results in encouraging those who have won. We strive to develop our products and services to be of high quality and acceptable.



### labrador was awarded by DEmark Award and GOOD DESIGN Award

The winning product receives the DEmark logo for outstanding design, which can be used to promote well-designed Thai products in the international market. It is hoped that this award will help promote development of domestic products, which will in turn better the quality of life of both domestic and international consumers.

Inspired by simplicity of nature, Labrador products are elaborately craft-made under the concept of "Truth to materials".

To expose the senses of real feeling, touching, and look; we believe that the nature of materials should not be hidden.

The materials used are particularly selected, the full grain aniline leather at its best quality, which enable us to maximize the use of the materials and cause less waste. The materials' premium quality reflects on its durability and beautifully aged.

Labrador, we love creating. The design begins with the way we look at the environment and life balancing. This identity makes our design bold yet simple, natural however unique. We wish the design of Labrador product somehow implied that life should be simple.

#### RESEARCH + DESIGN + MOCK UP

- research
- sketch design
- mock up model

#### NATURAL TO BE EXPOSED

- low chemical applied
- imperfectness is perfect
- recyclable material
- tanning process is emphasized to the most natural touch & feel
- leather the most artistic and valuable material ever

Please note that because each of product is natural leather, there may be slight variation in color and texture. That make leather the most artistic and valuable material ever. The appearances of any of published products may be change for product improvement without notice.

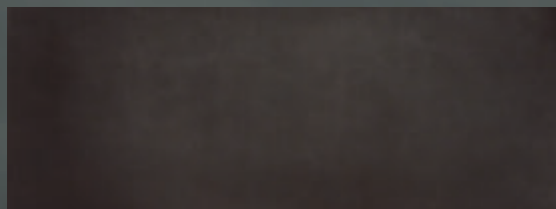

DARK CHOC (DCH)

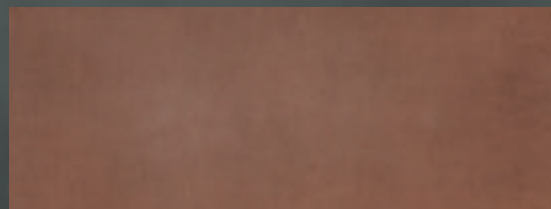

TAN (TAN)



DEEP GREEN (GRN)



DARK CONCRETE (DCO)

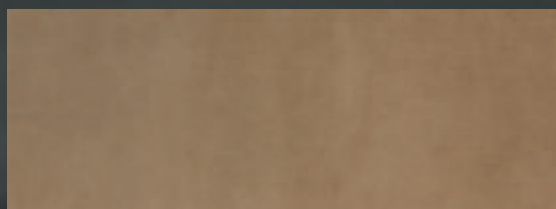

LIGHT BROWN (LBN)

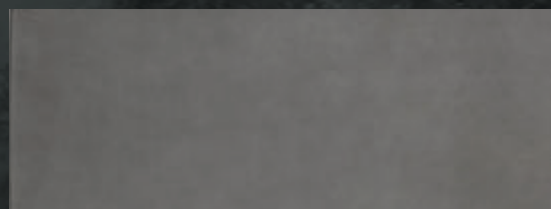

GREY (GRY)



ARCHITECT BLACK (ABK)

only specific items



DARK CHOC SUEDE (DCS)

#### TIPS!

- When leather gets wet, clean it with dry cloth and keep it in open and shady area
- Small scratch can be fixed by finger rubbing. Dark stain can be removed by rubber, eraser type of cleaner. Please do not rub too hard.
- Use soft and dry cloth for leather daily care. Cream can be used once in a while or used to make up oily content. Alcoholic solvents such as thinner and gasoline are not recommended.
- Leather needs breathing, thus when stored, dust have to be cleaned and kept in open space.





THE BAGS ARE DESIGNED TO ATTAIN HIGHEST MATERIAL CAPABILITY AND TO MEET SMARTEST SIMPLE FORM.

"humble" is bag collection that is well calculated form. They are able to wrap stuff inside and restore back to the original form itself after taking the stuff out. The bags are designed to reach the highest material capability and to form smartest simple form. Final design create durability of heavy-duty carrier and practical usage. Genuine leather is our main purpose to serve a long-lasting product to customer.



HUMBLE BAG COLLECTION #1



A34 | bag L#1  
W52 H43 D2 cm

A minimalistic bag that designed practically for paper, sketchbook, drawing, magazine, and wide-screen laptop. With labrador own-technique of leather, the body of bag can be stretched to wrap the object inside. In spite of its very sleek look, it is actually very tough.



A50 | bag M#1  
W46 H39 D2 cm



A35 | bag S#1  
W40 H35 D2 cm



HUMBLE BAG COLLECTION #2



A38 | bag L#2  
W52 H43 D2 cm

A minimalistic bag that designed practically for paper, sketchbook, drawing, magazine, and wide-screen laptop. With labrador own-technique of leather, the body of bag can be stretched to wrap the object inside. For more space, Bag#2 has 3 compartments with the zipper in the middle. In spite of its very sleek look, it is actually very tough.



A51 | bag M#2 \*  
W46 H39 D2 cm



A39 | bag S#2  
W40 H35 D2 cm







THE BAG BODY IS COMPOSED FROM ONLY 2 PARTS

"X" design prevent bag's bottom from stain. It has magnetic lock and also comes with a comfy shoulder strap. Tote it simple way.



**A91 | X tote bag L**  
W35 H44 D14 cm

spacious / large-sized  
X tote bag : "X" design prevent bag's bottom from stain. It has magnetic lock and also comes with a comfy shoulder strap. Tote it simple way.



**A92 | X tote bag M**  
W32 H39 D10 cm

practical / medium-sized



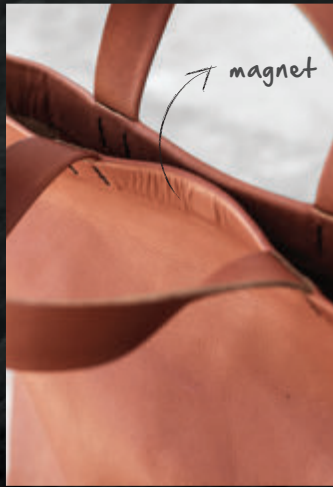

**A124 | X hand bag M**  
 W30 H34 D12.5 cm  
 handy / small - size / zip  
 "X" design prevent bag's bottom from stain "hold it simple way"

■ DCH ■ TAN ■ GRN ■ DCO ■ ABK



**A93 | X hand bag S**  
 W25.5 H25.5 D10 cm  
 X hand bag S: "X" design prevent bag's bottom from stain and has magnetic lock. Hold it simple way

■ DCH ■ TAN ■ GRN ■ DCO ■ ABK

X DESIGN PATTERN PREVENT BAG'S  
BOTTOM FROM STAIN.



**A125 | X shoulder bag M**  
W30 H34 D12.5cm

Adjustable strap / comfy shoulder strap/  
zip / key holder "X" design prevent  
bag's bottom from stain "shoulder it  
simple way"



**A96 | X shoulder bag S**  
W25.5 H25.5 D10 cm

X shoulder bag S : "X" design prevent  
bag's bottom from stain. It has zip and also  
comes with a comfy adjustable shoulder  
strap. Shoulder it simple way

DCH TAN GRN DCO ABK





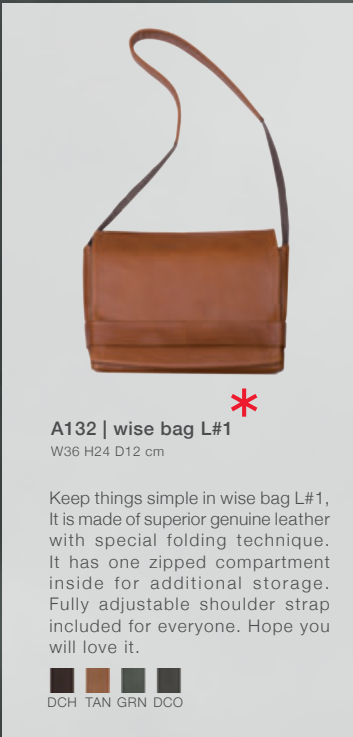

**A132 | wise bag L#1**  
W36 H24 D12 cm

Keep things simple in wise bag L#1, It is made of superior genuine leather with special folding technique. It has one zipped compartment inside for additional storage. Fully adjustable shoulder strap included for everyone. Hope you will love it.

- DCH
- TAN
- GRN
- DCO



adjustable shoulder strap



hidden zip pocket



magnet



shoulder pad

A NEW DESIGN FROM FOLDING LEATHER INTO A BAG SHAPE CREATES THE DIFFERENTIATION AND NEW WISE BAG IDENTITY.



premium nyllex with water repellent coating for durability, high-density EVA foam

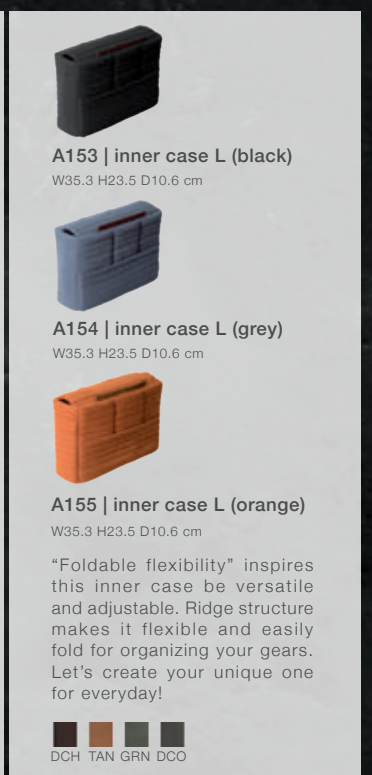
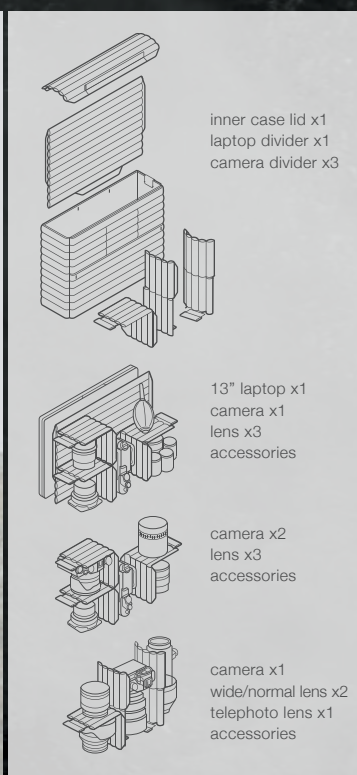



**A99 | wise bag M#1**  
W30.5 H22 D9.5 cm

Keep things simple in wise bag, It is made of superior genuine leather with special folding technique. It has two pockets and one zipped compartment inside for additional storage. Fully adjustable shoulder strap included for everyone. Hope you will love it.

- DCH
- TAN
- GRN
- DCO
- ABK





**A97 | wise bag S#1** \*

W24 H18 D6.5 cm

**A98 | wise bag S#2**

W27.5 H15 D6.5 cm

Keep things simple in wise bag, It is made of superior genuine leather with special folding technique. It has two pockets and one zipped compartment inside for additional storage. Fully adjustable shoulder strap included for everyone. Hope you will love it.

DCH TAN GRN DCO ABK





**A27 | wallet #1 \***

W8.5 H10 D0.8 cm

Made from only one piece of superior genuine leather, wallet#1 is a stylish sleek one that reminds you to keep only important cards and some banknotes in order to prevent you from having unnecessary cards which make your wallet bulky and miss-shaped.

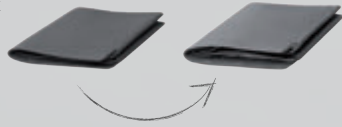
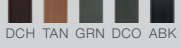

the thickness with stuff inside is only 1.1 cm



**A111 | wallet #2 \***

W10 H9 D0.9 cm

Wallet#2 is designed to balance between thinness and functions. It also reminds you to keep only useful cards and some banknotes, in order to prevent you from having unnecessary things. Four cards slots are provided, and one special hidden card slot. Easy to slip down in your pocket. Hope this fit your minimal lifestyle.



the thickness with stuff inside is only 1.1 cm



**A85 | fold wallet M#3 \***

W18 H9.5 D1.5 cm



**A86 | fold wallet S#3 \***

W10 H9.5 D1.5 cm

Simply organize things with fold wallet. It is made of superior genuine leather which make it last-longer and very durable. The ability to store banknote, coins, and cards, go infinite with its minimal design. Hope you will love it.

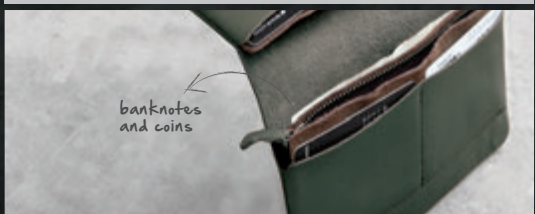

**A118 | passport wallet S#1**

W11 H13 D2 cm

Simply organize things with passport wallet S#1. It is made of superior genuine leather which make it last longer and very durable which makes it durable yet, enable to store passport, coins, cards and banknotes. Hope you will love it.

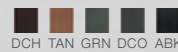

"PUBB" collection is made of superior genuine leather with folding craft technique. It is practically designed to make sure that your precious possessions will be safe with a magnet lock. We hope you will love it.

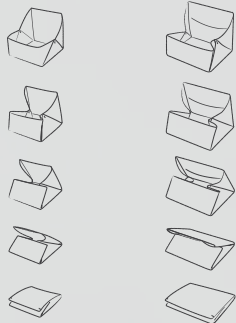

PUBB coin pocket PUBB wallet



A82 | PUBB coin pocket  
W7 H6.5 D1.5 cm



A83 | PUBB wallet #1 \*  
W10 H8 D1.5 cm

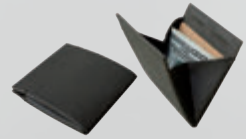
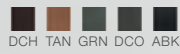

A152 | PUBB wallet #2  
W9.8 H10 D1.5 cm

"PUBB" wallet #2 is made of superior genuine leather with folding craft technique. Clean edges create the minimal form. Convenient and safe to carry with magnetic lock. Hope you will love it.



SUITABLE DAILY LIFE WITH MAGNETIC DESIGN WHICH MAKE IT MUCH MORE EASIER TO USE.



A17 | money clip #1 \*  
W4.5 H6 D1.5 cm

Convenient way to take the banknote with you. High power magnet give you the confidence that the banknote will not slip away.



A18 | money clip #2  
W7 H10.5 D1.5 cm

Money clip #2 is a money clip with a card insertion. High power magnet give you the confidence that the banknote will not slip away.



A117 | money clip #3  
W3 H7.7 D1.3 cm

Convenient way to take the banknote with you. High power magnet give you the confidence that the banknote will not slip away.

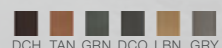





**A147 | zipper wallet L** \*

W23.5 H13 D2.5 cm

Simply keep things organized and convenient with zipper wallet L. It is made of superior genuine leather which makes it last-longer. It has three card slots, one pocket and one zip compartment to store banknotes and coins. It also comes with an adjustable shoulder strap. With its minimal design, hope you will love it.

DCH TAN GRN DCO ABK



adjustable shoulder strap



phone slot



banknote slot

card slots



phone slot

zip



card slot



**A101 | zipper wallet M**

W20 H10 D2 cm

Simply keep things organized and convenient with zipper wallet M. It is made of superior genuine leather which makes it last-longer. It has two card slots, one pocket and one zip compartment to store banknotes and coins which go infinite with its minimal design. Hope you will love it.

DCH TAN GRN DCO ABK



card slot

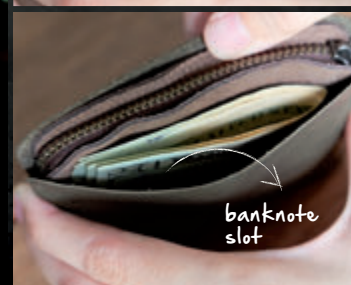

banknote slot



**A131 | zipper wallet S** \*

W11.6 H8.8 D2 cm

Simply keep things organized and convenient with zipper wallet S. It is made of superior genuine leather which makes it last-longer. It has two slots and one zip compartment to store banknotes and coins. With its minimal design, hope you will love it.

DCH TAN GRN DCO ABK



banknote slot  
zip



boarding pass/  
ticket

**new arrival**

passport slot

card slots



**A145 | travel wallet M \***

W10.5 H19.3 D1 cm

Travel wallet M is a creative design to combine between passport case and wallet into one product. It is functionally designed for passport, boarding pass, ticket, six card slots, coins and banknotes. Hope you feel good along with it

DCH TAN GRN DCO



card slots

magnet

**new arrival**



passport slot



banknote slot



**A146 | travel wallet S \***

W10.5 H14.3 D0.8 cm

Travel wallet S is a creative design to combine between passport case and wallet into one product. It is functionally designed for passport, ticket, and two card slots. Hope you feel good along with it

DCH TAN GRN DCO



smart interlocking system without metal part

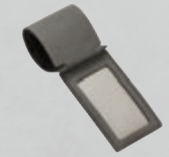

**A26 | luggage tag L**

W30 H6.5 D1 cm



**A25 | luggage tag M**

W30 H5 D1 cm

With a smart interlocking system without metal part, our luggage tag L and M can pass every metal detector at the gate way.

DCH TAN GRN DCO LBN GRY





**S78 | passport case M#3** \*

W12.5 H22.5 D2.5 cm

Passport case M#3 is a minimal-style passport case. It is functionally designed for passport, boarding pass, tickets, and cards. It is everything you need when traveling.

DCH TAN GRN DCO LBN GRY

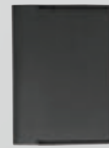

**S66 | passport case S#2** \*

W10 H13.7 D7 cm

Passport case S#2 is designed practically to fit cards, note, and passport. It takes very small space and very handy.

DCH TAN GRN DCO ABK



**S71 | passport case M#2**

W11 H19.5 D1 cm

Passport case M#2 is a minimal-style passport case, that functionally designed for passport, boarding pass, tickets, and cards. They are everything you need when traveling.

DCH TAN GRN DCO LBN GRY





**A128 | walker camera strap L#2** \*

W90-126 H4.7 D0.8 cm

Walker camera strap L#2. The strap is made of superior genuine leather. Adjustable strap is designed for various sizes of usage. In addition, the "AIR PAD" with air volume will provide you more comfortable than you expected. Hope walker camera strap be your camera's best friend.

DCH TAN GRN DCO



adjustable strap

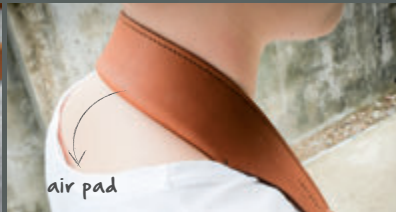

air pad



hidden ring



new arrival



new arrival

**A129 | walker camera strap M#2** \*

W90-126 H3.8 D0.8 cm

Walker camera strap M#2. The strap is made of superior genuine leather. Adjustable strap is designed for various sizes of usage. In addition, the "AIR PAD" with air volume will provide you more comfortable than you expected. Hope walker camera strap be your camera's best friend.

DCH TAN GRN DCO



**A130 | walker camera strap S#2** \*

W90-107.5 H1.8 D0.8 cm

Walker camera strap S#2. The strap is made of superior genuine leather. Adjustable strap is designed for various sizes of usage. In addition, the "AIR PAD" with air volume will provide you more comfortable than you expected. Hope walker camera strap be your camera's best friend.

DCH TAN GRN DCO



THE "AIR PAD" WITH AIR VOLUME  
WILL PROVIDE YOU MORE COMFORTABLE  
THAN YOU EXPECTED

**A136 | walker camera strap L#3** \*

W90-129 H4.7 D0.8 cm

**A137 | walker camera strap M#3** \*

W90-129 H3.8 D0.8 cm

**A138 | walker camera strap S#3** \*

W90-110.5 H1.8 D0.8 cm

Walker camera strap #3. The strap is made of superior genuine leather. Adjustable strap is designed for various sizes of usage. In addition, the "AIR PAD" with air volume will provide you more comfortable than you expected. Hope walker camera strap be your camera's best friend.

DCH TAN GRN DCO



new arrival



**A126 | laptop case 15"** \*

W43.5 H39 D3 cm



**A127 | laptop case 13"** \*

W38.5 H37 D3 cm

Laptop case 13", 15" is designed to fit 13", 15" Macbook Pro. The design is simple yet functional. The document slot provided outside with magnetic closing. Let's it be a partner with you and have a nice simple day.

■ DCH ■ TAN ■ GRN ■ DCO ■ ABK





THE NEOPRENE THAT PROVIDES SOFTNESS,  
SCRATCH PROTECTION, AND WATER RESISTANT.



**A78 | laptop softcase 15" #3**  
W40.5 H28 D3 cm



**A79 | laptop softcase 13" #3**  
W36.5 H25.3 D3 cm



**A135 | laptop softcase 12" #3**  
W34.5 H24 D3 cm

Softcase 12", 13", 15" is perfectly fit to macbook. It is made from 2 excellent material in the world. First is the neoprene that provides softness, scratch protection, and water resistant. Second is the high quality genuine leather that give you the elegant look and feel.

DCH TAN GRN DCO ABK



**A80 | document softcase M#3**  
W40.5 H28 D3 cm



**A81 | document softcase S#3**  
W36.5 H25.3 D3 cm

Document softcase M#3, S#3 is a minimal document case. It can carry your daily stuff such as documents, pens, cards. With its soft leather, it will protect your stuff from scratching.

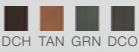

DCH TAN GRN DCO



card slot

pen holder



**A100 | iPad softcase**  
W27.5 H19.8 D1.3 cm



**A119 | iPad mini softcase**  
W24 H16 D1 cm

Softcase is perfectly fit to iPad and iPad mini. It is made from 2 excellent material in the world. First is the neoprene that provides softness, scratch protection, and water resistant. Second is the high quality genuine leather that give you the elegant look and feel.

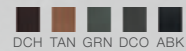

DCH TAN GRN DCO ABK





new arrival

---

SNAP ON AND OFF TO GET A QUICK ACCESS.

---



**A139 | SNAP iPad softcase** \*

W28.5 H20.5 D0.8 cm



**A140 | SNAP iPad mini softcase** \*

W23.5 H17 D0.8 cm



**A141 | SNAP clutch M** \*

W23.5 H14 D0.8 cm



**A142 | SNAP clutch S** \*

W19.6 H12 D0.8 cm



**A143 | SNAP pen pocket** \*

W19.6 H7.5 D0.8 cm



**A144 | SNAP card case** \*

W10.5 H7.5 D0.8 cm

Snap on and off to get a quick access. Simply organize your stuff with Snap collection. Get practical along with minimal design. Hope you will love it.

DCH TAN GRN DCO ABK



### S76 | card wallet \*

W9.7 H9.8 D1 cm

Minimal card wallet with two slots for name card, credit card, and another slot for banknote.

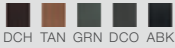

DCH TAN GRN DCO ABK



card slots

banknotes slot



### S77 | card sleeve

W9.5 H6.8 D1 cm

Minimal card sleeve with two slots for name card, credit card.

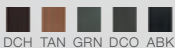

DCH TAN GRN DCO ABK



card slots



### S43 | card case #1 \*

W7 H10.5 D1.5 cm

A card case with 2 slots for name-cards, credit cards, etc. . .

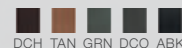

DCH TAN GRN DCO ABK



### S44 | card case #2 \*

W8 H11 D2 cm

A card case with opening space on cover for embedded chip cards (ex: metro card or pass card) and 3 more for any cards

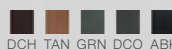

DCH TAN GRN DCO ABK



**S06 | card holder #1**  
W7.5 H10.5 D2 cm

Card holder is a minimal card holder. It can carry 20 cards with an interlock by leather string.

- - 
  - 
  - 
  - 
  -
- DCH TAN GRN DCO LBN GRY



**S23 | card holder #2** \*

W8 H10.5 D2 cm

Card holder is a minimal card holder. It can carry 20 cards with a pin lock for the ease-of-use

- - 
  - 
  - 
  - 
  -
- DCH TAN GRN DCO LBN GRY



**S24 | card holder XS #3** \*

W7.5 H10.5 D2 cm

Card holder is a minimal card holder. It can contain 12 cards with inside pockets at the front and back for the cards that you often use.

- - 
  - 
  - 
  - 
  -
- DCH TAN GRN DCO LBN GRY

strap M

strap L

card case #4

strap M

strap L

card case #5

**A103 | card case#4 + strap M**  
W7 H53 D0.5 cm

**A105 | card case#5 + strap M**  
W11 H49.5 D0.5 cm

**A102 | card case#4 + strap L**  
W7 H68 D0.5 cm

A horizontal card case with window for ID card and one more for any card. With the hole on the top, you can hang the card case with labrador strap

- 
- 
- 
- 
- 

DCH TAN GRN DCO ABK

**A104 | card case#5 + strap L**  
W11 H64.5 D0.5 cm

A vertical card case with window for ID card and one more for any card. With the hole on the top, you can hang the card case with labrador strap

- 
- 
- 
- 
- 

DCH TAN GRN DCO ABK





**A123 | bank passbook case #2**  
W11 H18.5 D1 cm

Bank passbook case #2 is practically designed for usage in real life. Its main purpose of design are ease of use and secure holding, contained up to 8 bank passbooks, easy to use with elastic. Hope you will love it.

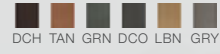

**S73 | card holder S#2**  
W12.5 H11.5 D1.8 cm

Card holder S#2 is a stylish card holder. Card holder is made of high quality leather, so we recommend you to clean it with leather cleaner, contained up to 40 cards, easy to use with elastic. Hope you will love it.

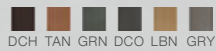

**S72 | card holder M#2**  
W19 H11.2 D1.8 cm

Card holder M#2 is a stylish card holder. Card holder is made of high quality leather, so we recommend you to clean it with leather cleaner, contained up to 60 cards, easy to use with elastic. Hope you will love it.





**A134 | cross keyring \***  
W3.6 H12 D1.5 cm

Interlocking system plays major role in cross keyring. Organized your key with functional and durable design.



**new arrival**

**A07 | keyring \***  
W2 H11.5 D1.5 cm  
A simple and practical keyring.

**A10 | cable keyring \***  
W3 H5 D1.5 cm  
A very simple yet very strong keyring.

**A133 | keyring L**  
W3.6 H14.8 D1.5 cm  
A simple and practical keyring.



**new arrival**



**A120 | key jacket #3 \***  
W5 H9 D1.5 cm

Key Jacket #3 easy to grab and use. Key Jacket #3 is designed to store at maximum 4-5 keys. The hole in the middle is to lock your keys tip. Made with superior genuine leather for long-lasting use. Hope you will love it.

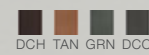

**A121 | key jacket #4 \***  
W6.5 H10.5 D1.3 cm

Key Jacket #4 is designed to organise your keys with minimal design. Closed with power magnetic to prevent any scratches that occur from your keys. With card pocket inside for your keycard. Made with superior genuine leather for long-lasting use. Hope you will love it.

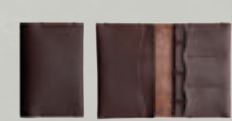

**A122 | key and card case**  
W10 H7 D1 cm

Simply organise your keys and cards with our "Key and Card Case" Easy for everyday use. Just put your room keys and keycard inside. Can be use though door access control systems. Hope you will love it.





A106 | phone case L#4  
W9.3 H17.8 D0.4 cm



A107 | phone case M#4  
W8.3 H15.8 D0.4 cm



A108 | phone case S#4  
W8 H14.7 D0.4 cm

A stylish leather case for smartphone comes with a card slot.

DCH TAN GRN DCO ABK



\*the strap is not included

detachable strap



card slot

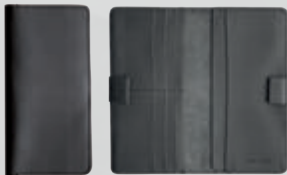

A109 | phone wallet L#1 \*  
W10 H18.7 D1 cm

Phone wallet L#1 is a creative design to combine between phone case and wallet into one product. It is very functional for your routine with six card slots and perfect fit your smartphone (for example iPhone 6 plus) and banknotes. Hope you feel good along with it.



A110 | phone wallet M#1 \*  
W9 H16.5 D1 cm

Phone wallet M#1 is ideally fit for your smartphone (for example iPhone 6) and banknotes, with an extra three card slots and key pocket. Make your routine more functional and convenient. Hope it simply fit your everyday activity.

DCH TAN GRN DCO ABK



banknote slot

magnet

card slots

for earphones plugged in



card slots

phone slot

key slot

magnet

for earphones plugged in



**S70 | pen case L#2**  
W4.5 H15.5 D0.5 cm

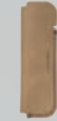

**S74 | pen case M#2**  
W8.8 H13.5 D0.5 cm



**S75 | pen case S#2**  
W8.8 H11.5 D0.5 cm

A pen case for 2 of your favorite pen.

- DCH
- TAN
- GRN
- DCO
- LBN
- GRY

**S19 | pen case #1**  
W4.5 H15 D2 cm

A compact leather pen case for your favorite pen.

- DCH
- TAN
- GRN
- DCO
- LBN
- GRY



**S21 | pocket M#1** \*

W11 H22 D2 cm

**S20 | pocket S#1**

W8.5 H18 D2 cm

Pocket M#1 and S#1 ; stylish pocket made of high quality soft leather with a classic style of fastened strap. It can contain stuff such as pens, notes and cosmetics. Hope you will love it.

DCS

**S56 | pocket M#2** \*

W11 H22 D2 cm

**S55 | pocket S#2**

W8.5 H18 D2 cm

Pocket M#2 and S#2 ; stylish pocket made of high quality soft leather with a classic style of fastened strap. It can contain stuff such as pens, notes and cosmetics. Hope you will love it.

- DCH
- TAN
- GRN
- DCO
- ABK





**A114 | cable clip #1**  
W2.5 H4 D1.5 cm

A cable clip for earphone or cable charger holder. Hope you will love it.

- - 
  - 
  - 
  - 
  -
- DCH TAN GRN DCO LBN GRY



**A149 | double cable clip \***

W4.8 H6 D2.2 cm

A cable clip for earphones or charging cable. Hope you will love it.

- - 
  - 
  -
- DCH TAN GRN DCO



**A148 | cable clip #2**

W4.5 H2 D1.8 cm

A cable clip for earphones or charging cable.

- - 
  - 
  -
- DCH TAN GRN DCO

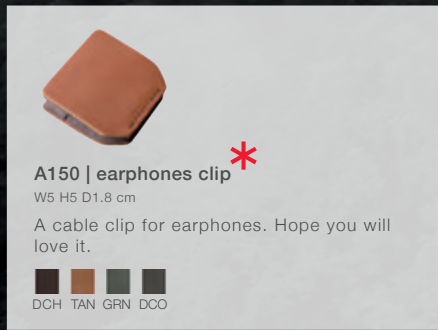

**A150 | earphones clip \***

W5 H5 D1.8 cm

A cable clip for earphones. Hope you will love it.

- - 
  - 
  -
- DCH TAN GRN DCO





**S67 | stitch case M** \*  
W15.5 H22.5 D2 cm



**S68 | stitch case S**  
W11.5 H16.5 D2 cm

Designed to fit our stitch notebooks A5 and A6, it is made of superior genuine leather and more elegant than ever. The minimal yet practical design make it easy to organize your notebook, and cards. It is lightweight, very handy and prompt. The best thing is it is refillable with stitch notebook inside.

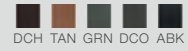

**S69 | pen holder band**  
W15 H3 D0.8 cm

Pen holder band is created for your most convenient to carry your notebooks and pens around. The band is perfectly fit for two notebooks (A5 or B6 size) with two pens.



**S13 | handy book M**  
W21.5 H21.5 D3 cm

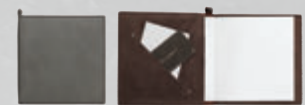

**S14 | handy book S**  
W16.6 H16.5 D3 cm

Handybook is a stylish sketchbook. It can collect everything you imagine. The leather strap on the spine is for your hand hold it comfortably. It contains 160 sheets of excellent paper. The paper is made for purpose of comfortably sketching. The handybook cover can be reused and refilled by the nudebook.





**S27 | organizer L#3**  
W18.5 H23.5 D4 cm



**S28 | organizer M#3** \*  
W13 H19 D2 cm

Leather organizer is a minimal design organizer. It helps you to manage your life in days, weeks, months, and years. In addition, labrador provides many types of refill paper suitable for specific usages. We use genuine leather because it is a long-lasting. Hope you will love it.



pen holder size is adjustable



**S38 | organizer L#5**  
W19.5 H24 D4 cm



**S39 | organizer M#5**  
W13.5 H19 D2 cm

Leather organizer is a minimal design organizer. It helps you to manage your life in days, weeks, months, and years. In addition, labrador provides many types of refill paper suitable for specific usages. With love and sincerity, we use genuine leather because it is a long-lasting and recyclable material. By doing that, we can help the world reducing trash.



**S57 | organizer L#6**  
W19.5 H23.5 D2.5 cm



**S58 | organizer M#6**  
W15 H19 D2 cm

Leather organizer is a minimal design organizer. It helps you to manage your life in days, weeks, months, and years. In addition, labrador provides many types of refill paper suitable for specific usages. We use genuine leather because it is a long-lasting. Hope you will love it.



**S63 | organizer L#7**  
W20 H23.5 D2 cm



**S64 | organizer M#7**  
W15 H19 D2 cm

A full function organizer designed for refill paper, pen, namecard, and many more. The strap at the front helps protecting you stuff from falling. You will enjoy every function as well as its compact size.



## PAPER REFILL FOR ORGANIZER L,M



### P01 | plain paper (100 sheets)

W14.5 H21 D1.5 cm

### P02 | line paper (100 sheets)

W14.5 H21 D1.5 cm

### P03 | weekly planer (100 sheets)

W14.5 H21 D1.5 cm



### P05 | plain paper (100 sheets)

W10.2 H17.3 D1.5 cm

### P06 | line paper (100 sheets)

W10.2 H17.3 D1.5 cm

### P07 | weekly planer (100 sheets)

W10.2 H17.3 D1.5 cm

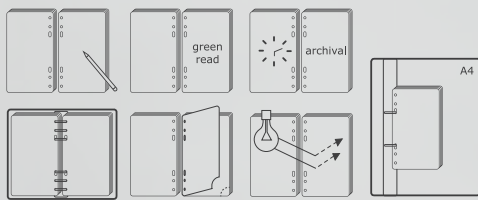

2- holes folder compatible  
usage-mark corner  
archival life paper  
green-read paper  
less reflective paper



2- holes  
folder  
compatible

usage  
mark  
corner

## NUDEBOOK FOR HANDYBOOK



### P11 | nudebook S (180 sheets)

W14.5 H14.5 D2.5 cm

### P10 | nudebook M (180 sheets)

W20 H20 D2.5 cm

Nudebook paper is sketching paper 320 gsm. For 2 first sheet on front and back covers. Inside paper is excellent quality of green-read paper 75 gsm.

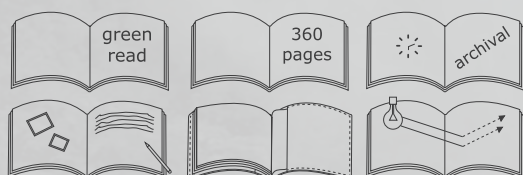

green-read paper  
archival life paper  
less reflective paper  
refill to handybook







## ARCHITECT BLACK

THIS IDEA SPARKED IN ONE EVENING WITH A QUESTION.  
"WHY DO ARCHITECTS WEAR BLACK?"

IS THAT A DRESS CODE FOR ARCHITECT OR IS SOMETHING  
THAT ARCHITECTS NEVER EVER THINK ABOUT.

THEN WE CREATED A NEW COLLECTION FROM OUR PASSIONS OF  
ARCHITECTURE THAT MAKE YOU LOOK CREATIVE LIKE ARTISTS,  
WORK LIKE ENGINEERS, GENERATE THINGS LIKE CRAFTSMEN.

HOW ABOUT, IF WE ASK YOU...  
"WHY DO ARCHITECTS WEAR BLACK?"

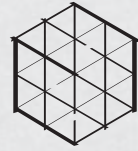

## ARCHITECT BLACK

THIS IDEA SPARKED IN ONE EVENING  
WITH A QUESTION.  
"WHY DO ARCHITECTS WEAR BLACK?"

IS THAT A DRESS CODE FOR ARCHITECT  
OR IT IS SOMETHING THAT ARCHITECTS  
NEVER EVER THINK ABOUT.

THEN WE CREATED A NEW COLLECTION  
FROM OUR PASSIONS OF ARCHITECTURE  
THAT MAKE YOU LOOK CREATIVE  
LIKE ARTISTS, WORK LIKE ENGINEERS,  
GENERATE THINGS LIKE CRAFTSMEN.

HOW ABOUT, IF WE ASK YOU...  
"WHY DO ARCHITECTS WEAR BLACK?"



### PRODUCT NAME

### QTY

- (1) X TOTE BAG L
- (2) X TOTE BAG M
- (3) X SHOULDER BAG M
- (4) X SHOULDER BAG S
- (5) X HAND BAG M
- (6) X HAND BAG S
- (7) WISE BAG M#1
- (8) WISE BAG S#1
- (9) WISE BAG S#2
- (10) PUBB WALLET #1
- (11) PUBB WALLET #2
- (12) PUBB COIN POCKET
- (13) PASSPORT WALLET S#1
- (14) FOLD WALLET M#3
- (15) FOLD WALLET S#3
- (16) WALLET #1
- (17) WALLET #2
- (18) ZIPPER WALLET L
- (19) ZIPPER WALLET M
- (20) ZIPPER WALLET S
- (21) PHONE WALLET L#1
- (22) PHONE WALLET M#1

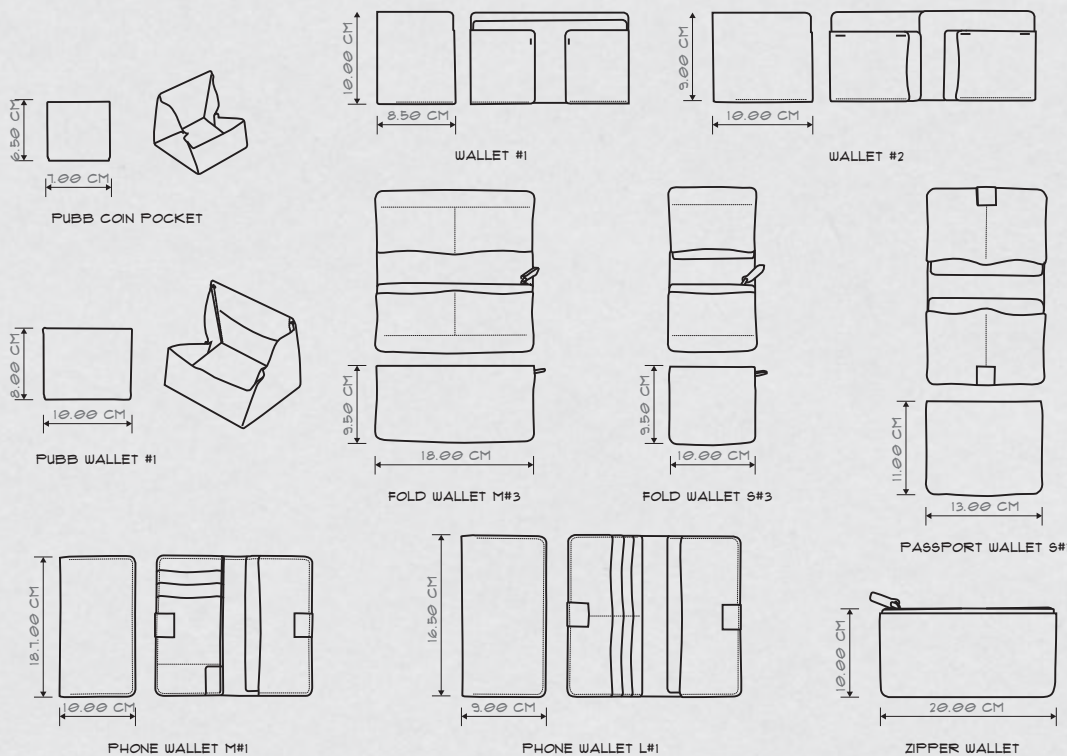



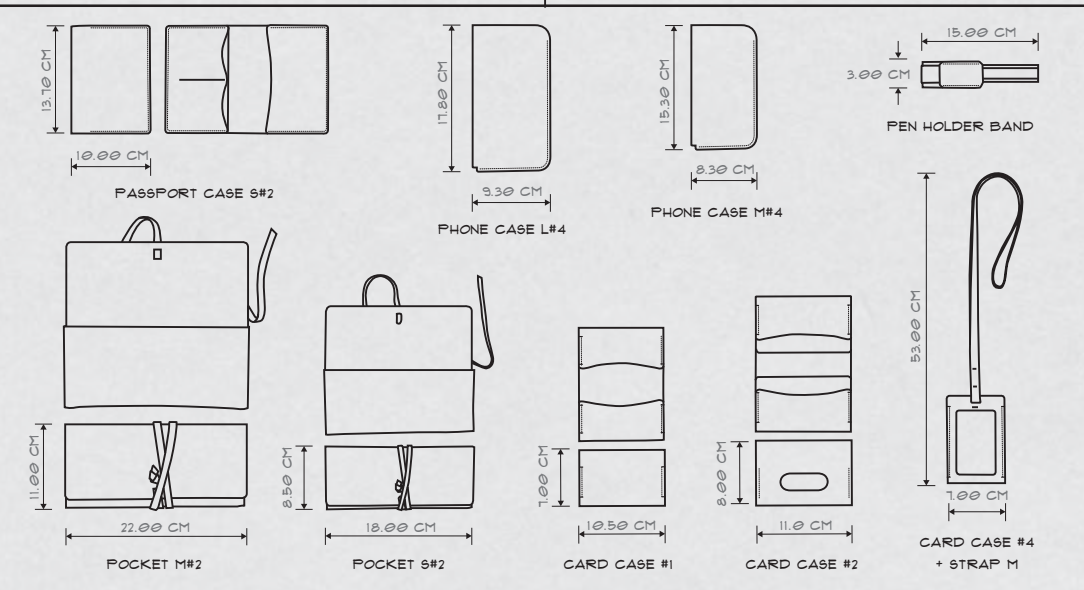

PRODUCT NAME	QTY
(23) PHONE CASE L#4	
(24) PHONE CASE M#4	
(25) PHONE CASE S#4	
(26) PASSPORT CASE S#2	
(27) PEN HOLDER BAND	
(28) POCKET M#2	
(29) POCKET S#2	
(30) CARD CASE #1	
(31) CARD CASE #2	
(32) CARD CASE #4 + STRAP L	
(33) CARD CASE #4 + STRAP M	
(34) CARD CASE #5 + STRAP L	
(35) CARD CASE #5 + STRAP M	
(36) CARD WALLET	
(37) CARD SLEEVE	

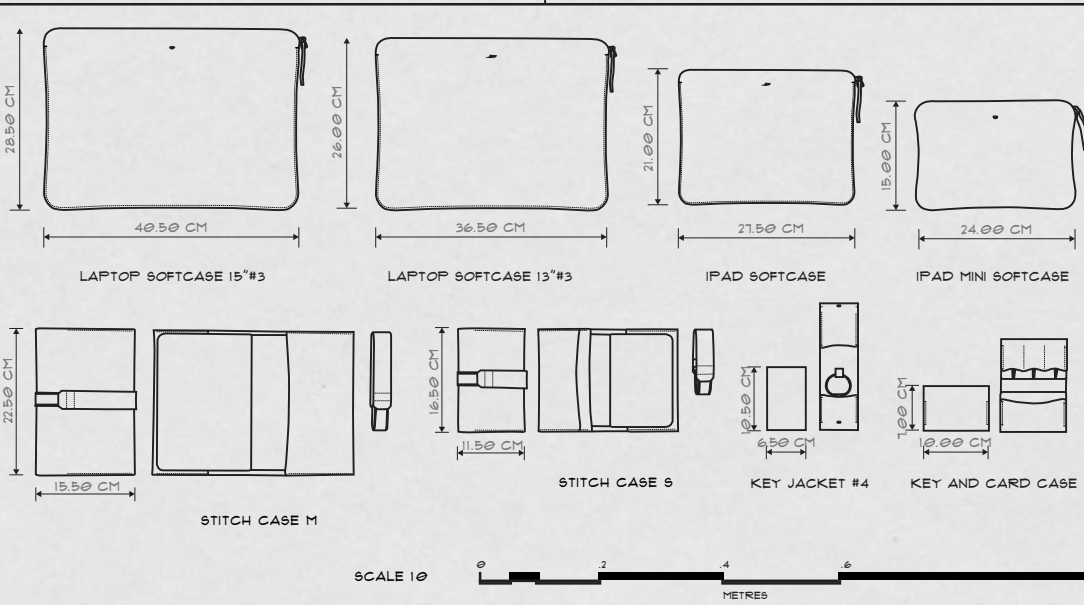

PRODUCT NAME	QTY
(38) LAPTOP SOFTCASE 15" #3	
(39) LAPTOP SOFTCASE 13" #3	
(40) LAPTOP SOFTCASE 12" #3	
(41) LAPTOP CASE 13"	
(42) LAPTOP CASE 15"	
(43) IPAD SOFTCASE	
(44) IPAD MINI SOFTCASE	
(45) STITCH CASE M	
(46) STITCH CASE S	
(47) KEY JACKET #4	
(48) KEY AND CARD CASE	
(49) SNAP IPAD SOFTCASE	
(50) SNAP IPAD MINI SOFTCASE	
(51) SNAP CLUTCH M	
(52) SNAP CLUTCH S	
(53) SNAP PEN POCKET	
(54) SNAP CARD CASE	



JOB NO.	
MATERIAL :	
FINISH :	
 ARCHITECT BLACK	PRODUCT DRAWING SCALE 1:50      SHEET 2 OF 2 DATE : DECEMBER 2016
	APPROVES :

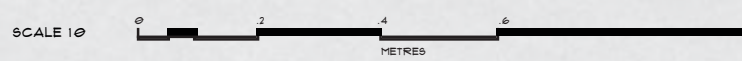

RE labrador

RElabrador, we use recycled leathers because they are eco-friendly, made up of 65% leather fiber and leather scraps that would otherwise go waste. It is then reconstituted with 20% natural latex, 10% natural fat, and 5% tanning oil. Our green production technology reuses 50% of water, and our waste heat recovery system ensures there will be no pointlessly waste of energy.

We believe that eco-friendly products are an effective method of environmental conservation. As they are made with sustainable design and their longevity helps reduce waste. How simplicity it is makes RElabrador very extraordinary handcraft item.

It's crafted from recycled leather and love

## REcycled leather how it's made?

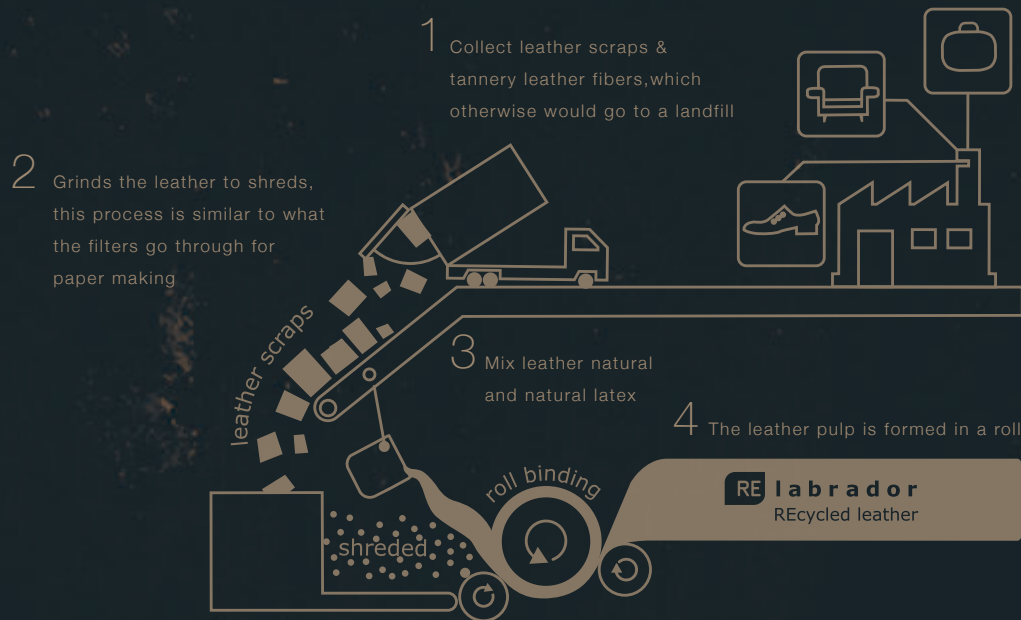

Please note that because each of product is natural recycle leather, there may be slight variation in color and texture. That makes recycle leather the most artistic and valuable material ever.



The appearances of any of published products may be changed for product improvement without notice.

**100%** RECYCLED NATURAL DESIGN

it's crafted from recycled leather and love

made in thailand

### RElabrador and award



#### RElabrador was awarded by Design innovation contest 2012

The Design Innovation Contest (DIC) is designed to stimulate and promote the development of innovative products with style, style, new models, focusing on creative designs that are different. Including the need for technology adoption. Academic work that improves the usability production technology Material selection



#### RElabrador was awarded by DEmark Award and GOOD DESIGN Award

The winning product receives the DEmark logo for outstanding design, which can be used to promote well-designed Thai products in the international market. It is hoped that this award will help promote development of domestic products, which will in turn better the quality of life of both domestic and international consumers.



new arrival

REshopper #2



RA49 | REshopper #2 \*

W29 H36.5 D11 cm

With the folding technique, the structure is constructed by tighten leather straps. It is capable of 7 kg capacity.







**REtable tray**

**RS73 | REtable tray #1**  
W6.5 D6.5 H3.5 cm



**RS74 | REtable tray #2**  
W12 D6.5 H3.5 cm



**RS75 | REtable tray #3**  
W21 D5.5 H4.5 cm



**RS76 | REtable tray #4**  
W10 D10 H5.5 cm



**RS77 | REtable tray #5**  
W10 D10 H10 cm



REtable tray is a minimalist set of stationery. Designed with hidden functions for simplicity look. With clasping technique make the product more stable in shape and stronger. REtable tray come in various sizes to organize all stuffs on your desk. Let your workspace neat with REtable tray.

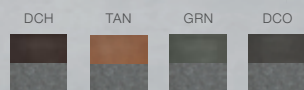

**REdeskpad**

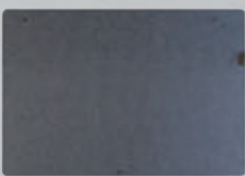

**RS78 | REdeskpad L**  
W66 H47 D0.2 cm

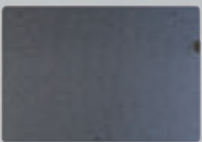

**RS79 | REdeskpad M**  
W55 H38 D0.2 cm

REdeskpad It's made from recycled leather. REdeskpad is combined with pen holder and two hidden magnets for paper clips. The design is clean and simple.



**new arrival**



## REfolder



**RS03 | REfolder A3**  
W32.5 H44.5 D0.5 cm



**RS04 | REfolder A4**  
W24 H32.5 D0.5 cm

It contains 120 pages of 75 gsm. green-read paper. Made from recycled leather so it is totally eco-friendly. The sewn-spine make it even more stronger. Available in A5, A6 sizes with plain, lined, and grid paper.

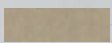

Ivory



grey



brown



Thailand - Japan Design Award Partnership

REfolder was awarded by DEmark Award and GOOD DESIGN Award in 2012

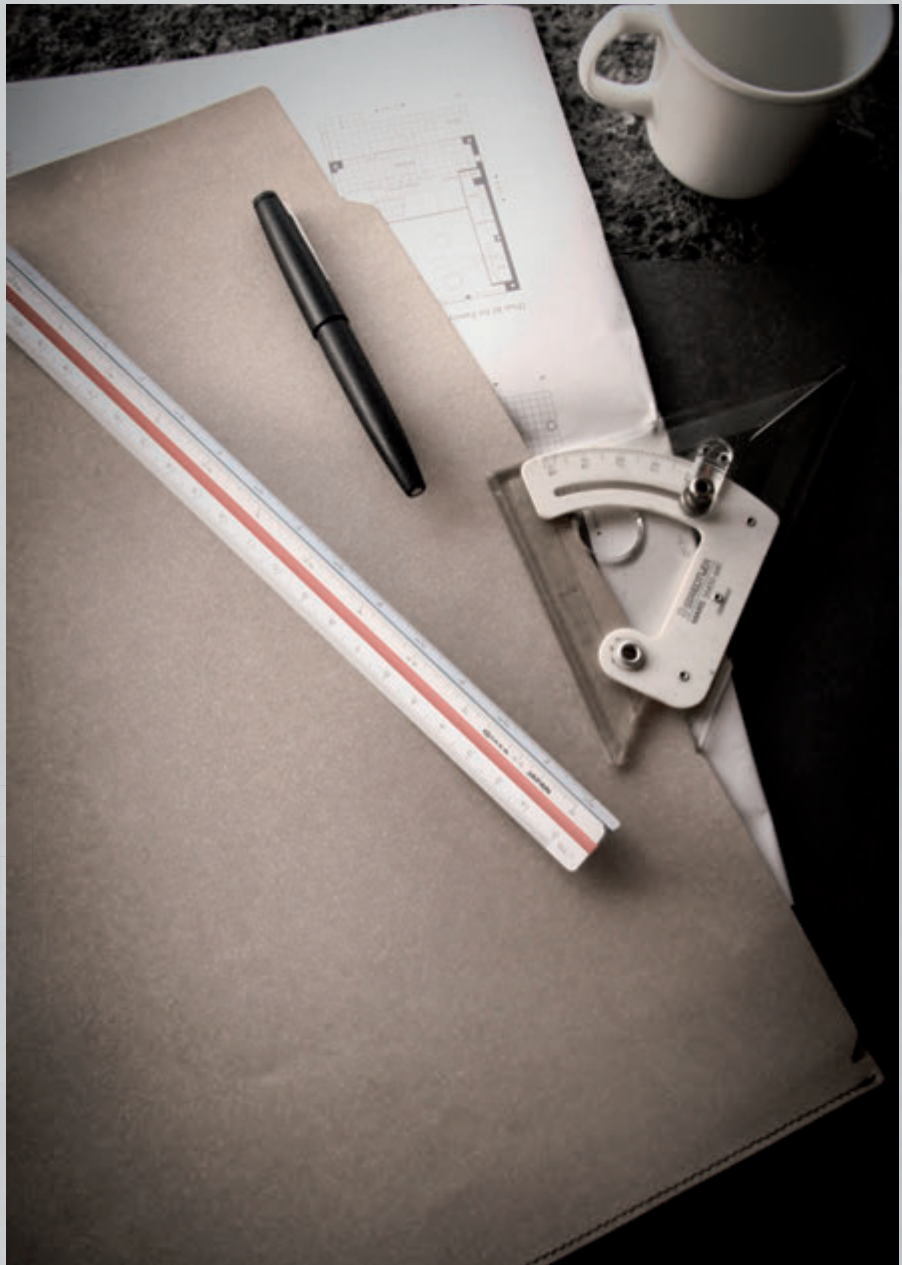



plain

lined

grid

## REnote



**RS67 | REnote A5 (plain paper)**  
W15 H21 D0.7 cm



**RS70 | REnote A6 (plain paper)**  
W10.5 H14.7 D0.7 cm



**RS68 | REnote A5 (lined paper)**  
W15 H21 D0.7 cm



**RS71 | REnote A6 (lined paper)**  
W10.5 H14.7 D0.7 cm



**RS69 | REnote A5 (grid paper)**  
W15 H21 D0.7 cm



**RS72 | REnote A6 (grid paper)**  
W10.5 H14.7 D0.7 cm

It contains 120 pages of 75 gsm. green-read paper. Made from recycled leather so it is totally eco-friendly. The sewn-spine make it even more stronger. Available in A5, A6 sizes with plain, lined, and grid paper.

Designing eco-friendly notebook comes from observing and analyzing notebook users. We select recycled leather for cover because it makes the REnote lighter and sewn-spine makes it stronger. Every line and grid was drawn by hand which makes it unique for every REnote.



Ivory

grey

brown



Thailand - Japan Design Award Partnership

REnote was awarded  
by DEmark Award and GOOD DESIGN Award in 2013

# EXTRA

LIGHT BAG

ONCE WE TIRED OF LAME,  
USELESS PRODUCTS  
THESE DAYS,  
WE STARTED !!

WWW.LABRADORFACTORY.NET  
WWW.FACEBOOK.COM/ZONNPROJECT

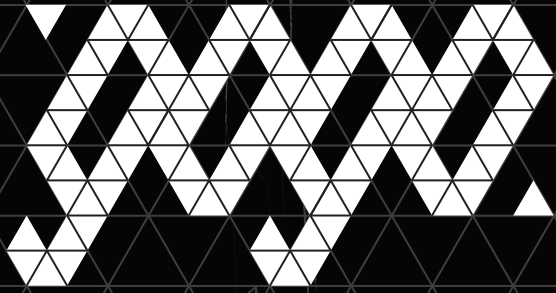

DESIGNED BY

100%  
RECYCLABLE

WATER  
RESIS-  
TANCE

WATER / OIL  
ABRASIVE / TEAR  
FADE / STAIN  
- 73°C  
104°C

PVC  
FREE

FOLD  
FLAT\_

SPACE SAVING FIT  
IN YOUR POCKET  
WHEN YOU TRAVEL

TY<sup>®</sup>  
VEK

IT IS TRULY  
INNOVATIVE  
MATERIAL  
THAT CAN  
LEAD US  
TO  
BETTER LIFE.

48° 51' 30.2" N 2° 17' 40.1" E  
43° 13' 37.8" N 122° 41' 24.1" W

LOW WASTE DESIGN



oddodd  
MESSENGER BAG

ZNA031-09  
ODDODD  
MESSENGER BAG  
PARIS RIVERBANK

ZNA031-10  
ODDODD  
MESSENGER BAG  
PARIS EIFFEL STRUCTURE

ZNA031-11  
ODDODD  
MESSENGER BAG  
UMPQUA SHADOW

ZNA031-12  
ODDODD  
MESSENGER BAG  
UMPQUA FOREST



W 43 cm  
H 27 cm  
D 13 cm  
0,19 kg

# oddodd messenger bag



PoiPoi  
TOTE

ZNA033-09  
POIPOI  
TOTE  
PARIS RIVERBANK

ZNA033-10  
POIPOI  
TOTE  
PARIS EIFFEL STRUCTURE

ZNA033-11  
POIPOI  
TOTE  
UMPQUA SHADOW

ZNA033-12  
POIPOI  
TOTE  
UMPQUA FOREST



W 36 cm  
H 40 cm  
D 05 cm  
0,07 kg

# PoiPoi tote

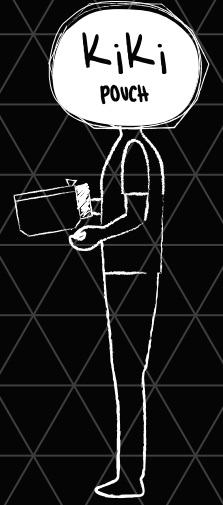

Kiki  
POUCH

ZNA034-09  
KIKI  
POUCH  
PARIS RIVERBANK

ZNA034-10  
KIKI  
POUCH  
PARIS EIFFEL STRUCTURE

ZNA034-11  
KIKI  
POUCH  
UMPQUA SHADOW

ZNA034-12  
KIKI  
POUCH  
UMPQUA FOREST



W 20 cm  
H 14 cm  
D 4,5 cm  
0,02 kg

# Kiki pouch



eiei  
SHOULDER BAG

ZNA032-09  
EIEI  
SHOULDER BAG  
PARIS RIVERBANK

ZNA032-10  
EIEI  
SHOULDER BAG  
PARIS EIFFEL STRUCTURE

ZNA032-11  
EIEI  
SHOULDER BAG  
UMPQUA SHADOW

ZNA032-12  
EIEI  
SHOULDER BAG  
UMPQUA FOREST

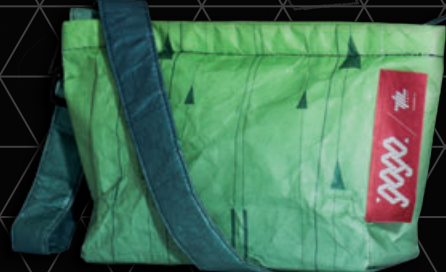

W 31,5 cm  
H 19 cm  
D 10 cm  
0,12 kg

# eiei shoulder bag

## ▲ ENVIRONMENTAL DATA

- 100% RECYCLABLE
- LOW WASTE DESIGN
- LOW ENERGY PRODUCTION
- PVC FREE
- LESS TRANSPORTATION

## ▲ MAINTENANCE

- COOL TEMPERATURE
- DO NOT TUMBLE DRY
- MILD DETERGENT
- DRY IN THE SHADE
- DO NOT WRING
- DO NOT IRON

## ▲ RESISTANCE

- WATER / OIL
- ABRASIVE / TEAR
- FADE / STAIN
- 73 °C
- 104 °C



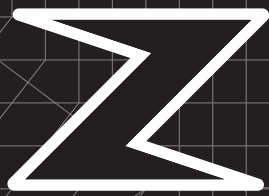

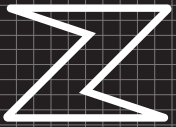

SINCE WE HAD BEEN FASCINATED BY THE BEAUTY OF PAPER WRINKLE, IT'S THE START OF Z SERIES. THROUGH AN EXPERIMENTAL DESIGN PROCESS, WE PROUDLY PRESENT TO YOU THE AMAZING SPACE FROM Z SERIES.

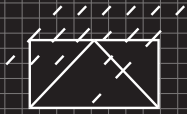

**WATER RESISTANCE**

THE PRODUCTS ARE MADE OF WATER RESISTANT WASHABLE PAPER.

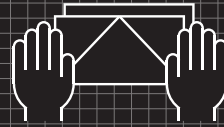

**HAND ASSEMBLY**

THIS SOPHISTICATED DESIGN IS GENTLY ASSEMBLED AS A CRAFT WORK, PIECE BY PIECE, BY OUR OWN SKILLFUL PEOPLE IN A GOOD WORKING ENVIRONMENT.



**ECO-FRIENDLY MATERIAL**

THE MATERIAL IS MADE OF RECYCLE FIBRE. PRINTED WITH SOY INK.



**TEAR RESISTANCE**

MAKING THE STRUCTURE AND SURFACE STRONGER, IT'S TEAR RESISTANT AND DURABLE MATERIAL.

# USE IT CREATIVELY!

## NOT A PAPER

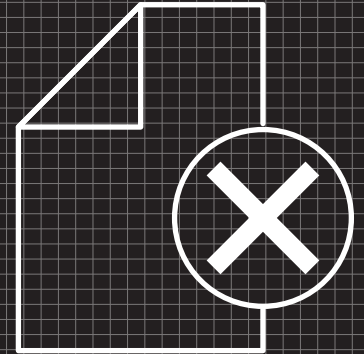

Z SERIES IS MADE OF A PROPRIETARY BLEND OF NATURAL CELLULOSE FIBRE PRODUCED IN GERMANY. THIS MATERIAL IS LIGHT, WATER RESISTANCE, AND TEAR RESISTANCE.



NATURAL  
CELLULOSE FIBRE

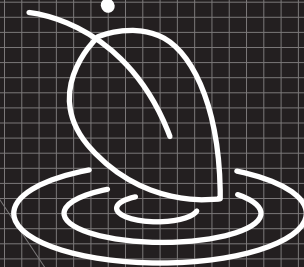

LATEX  
IMPREGRATED

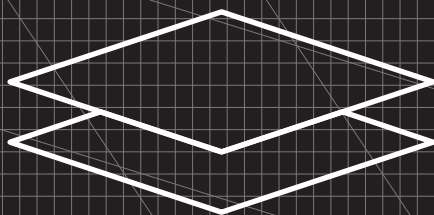

PULP FIBRE  
BLENDS

WATER  
RESISTANCE

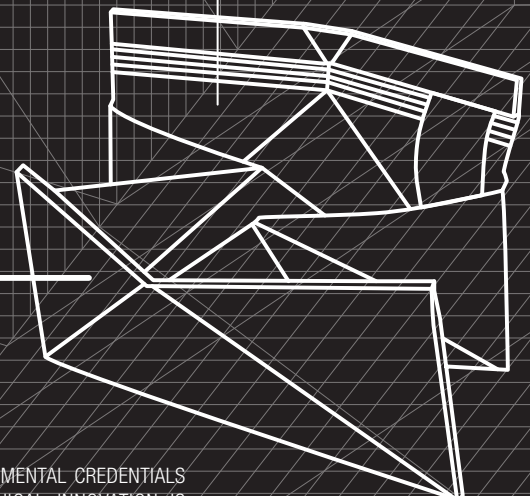

TEAR  
RESISTANCE

Z SERIES TAKE THEIR ENVIRONMENTAL CREDENTIALS VERY SERIOUSLY. OUR TECHNICAL INNOVATION IS FOCUSED NOT ONLY ON DEVELOPING SUSTAINABLE PRODUCTS BUT ALSO ON PROCESSES THAT WILL REDUCE OUR IMPACT ON THE ENVIRONMENT BY REDUCING CO2 EMISSIONS, ENERGY CONSUMPTION AND THE USE OF FRESH WATER IN OUR MANUFACTURING OPERATIONS.



## Z WALLET

USE IT CREATIVELY !

INTRODUCING THE Z WALLET, THE BEST START OF THE EXPERIMENTAL EXPERIENCE IN YOUR HAND. THE SPACE INSIDE IS DESIGNED FOR BANKNOTES, COINS, RECEIPTS, CARDS AND IPHONE 6. TRY WHAT ELSE CAN FIT IN Z WALLET, AND LET'S SEE HOW Z WALLET CAN HELP YOU ORGANIZE!.

- ZNA006-01  
Z WALLET (BLACK)
- ZNA006-02  
Z WALLET (GREY)
- ZNA006-03  
Z WALLET (MINT)
- ZNA006-04  
Z WALLET (RED)
- ZNA006-05  
Z WALLET (NAVY BLUE)
- ZNA006-06  
Z WALLET (CARMEL)

MAGNET

BANKNOTES,  
COINS

SMART PHONE

UP TO 4 CARDS  
PER SLOT,  
RECEIPTS

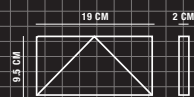
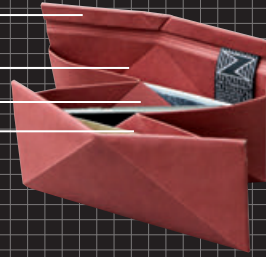

DIMENSION



EVERYTHING FOR Z WALLET

## Z TRAVEL CASE

USE IT CREATIVELY !

THE VERY GOOD MULTI-FUNCTION CASE FROM Z SERIES. THE Z TRAVEL CASE IS DESIGNED FOR PASSPORT, CARDS, A6 NOTEBOOK, BOARDING PASS, MAPS, AND PEN. A CASUAL WALK WITH Z TRAVEL CASE WILL BE YOUR INTERESTING CHOICE!.

- ZNA014-01  
Z TRAVEL CASE (BLACK)
- ZNA014-02  
Z TRAVEL CASE (GREY)
- ZNA014-03  
Z TRAVEL CASE (MINT)
- ZNA014-04  
Z TRAVEL CASE (RED)
- ZNA014-05  
Z TRAVEL CASE (NAVY BLUE)
- ZNA014-06  
Z TRAVEL CASE (CARMEL)

MAGNET

PEN HOLDER

BOARDING PASS,  
MAP

PASSPORT

BANK PASSBOOK  
NOTEBOOK A6

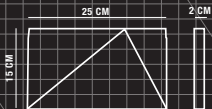

DIMENSION

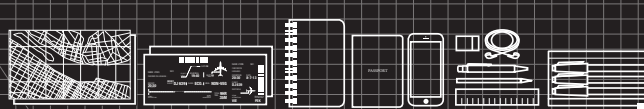

EVERYTHING FOR Z TRAVEL CASE

## Z FOLDER

USE IT CREATIVELY !

HAVE YOUR PAPER WELL ORGANIZED IN A FOLDER. Z FOLDER, THE SMART WAY TO CARRY DOCUMENTS, MAGAZINES OR EVEN YOUR PORTFOLIO. PEN HOLDER IS PROVIDED INSIDE. IT IS SPACIOUS, DURABLE, WATER RESISTANT, TEAR RESISTANT, AND LIGHT. BE CONFIDENT WITH Z FOLDER.

- ZNS010-01  
Z FOLDER (BLACK)
- ZNS010-02  
Z FOLDER (GREY)
- ZNS010-03  
Z FOLDER (MINT)
- ZNS010-04  
Z FOLDER (RED)
- ZNS010-05  
Z FOLDER (NAVY BLUE)
- ZNS010-06  
Z FOLDER (CARMEL)

MAGNET

PEN HOLDER

PORTFOLIO

MAGAZINE A4

A4 DOCUMENT  
UP TO 200 SHEET

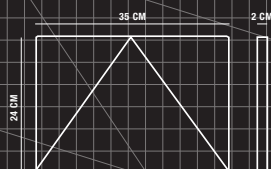
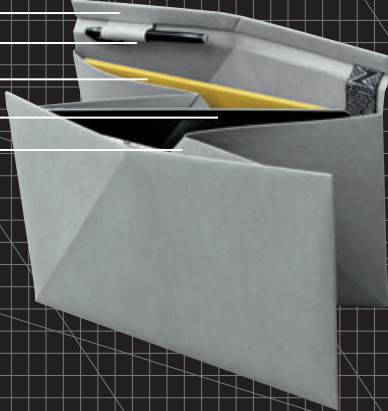

DIMENSION

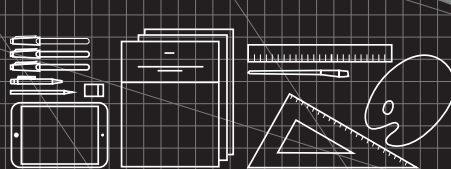

EVERYTHING FOR Z FOLDER

# Z NOTE

USE IT CREATIVELY !

Z NOTE IS SOMETHING MUCH MORE THAN YOU SEE. IT NOT ONLY JUST A NOTEBOOK COVER. WITH FOLDING PATTERN AND 4 POCKETS PROVIDED, Z NOTE IS REALLY EASY TO ORGANISE YOUR BUSY DAY. AND IT IS PERFECT FIT FOR YOUR WORKDAY TO YOUR DAY OFF. THE POCKETS'S SIZE ARE FIT FOR A5 NOTEBOOK, IPAD MINI AND YOUR SECRET DIARY.

- ZNS036-01  
Z NOTE (BLACK)
- ZNS036-02  
Z NOTE (GREY)
- ZNS036-03  
Z NOTE (MINT)
- ZNS036-04  
Z NOTE (RED)
- ZNS036-05  
Z NOTE (NAVY BLUE)
- ZNS036-06  
Z NOTE (CARMEL)

FOR IPAD MINI

CARDS,  
RECEIPTS

NOTEBOOK A5

EASY TO USE  
WITH ELASTIC

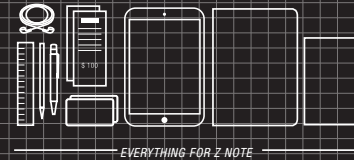
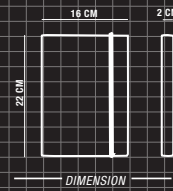

## Z BOX

USE IT CREATIVELY !

Z BOX IS A SIMPLE AND FUNCTIONAL MULTI BOX INSPIRES BY GEOMETRIC PATTERNS AND ORIGAMI TECHNICAL. THERE ARE 4 DIFFERENT SIZES FOR ORGANIZING STATIONERY ITEMS, ACCESSORIES TRAVEL ITEMS, OR WHATEVER ELSE YOU HAVE TO TAKE AWAY. EACH BOX IS FOLDED FROM A SINGLE SHEET THAT IS EMBEDDED WITH MAGNETS. SO YOU CAN EASILY TO USE THEM. USE THEM AS TRAYS, UTILITY CASE/ PENS / EYEGLASSES / PENCILS/ ACCESSORIES CONTAINERS



### Z BOX 4 x 15

USE IT CREATIVELY !

- ZNS015-01  
Z BOX 4X15 (BLACK)
- ZNS015-02  
Z BOX 4X15 (GREY)
- ZNS015-03  
Z BOX 4X15 (MINT)
- ZNS015-04  
Z BOX 4X15 (RED)
- ZNS015-05  
Z BOX 4X15 (NAVY BLUE)
- ZNS015-06  
Z BOX 4X15 (CARMEL)

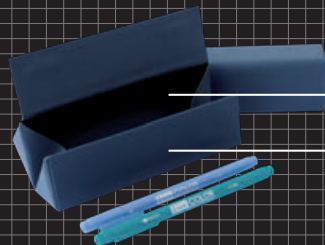

PENCILS,  
COMPACT PEN,  
COLOR MARKER

MAGNET

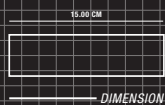

### Z BOX 4 x 18

USE IT CREATIVELY !

- ZNS016-01  
Z BOX 4X18 (BLACK)
- ZNS016-02  
Z BOX 4X18 (GREY)
- ZNS016-03  
Z BOX 4X18 (MINT)
- ZNS016-04  
Z BOX 4X18 (RED)
- ZNS016-05  
Z BOX 4X18 (NAVY BLUE)
- ZNS016-06  
Z BOX 4X18 (CARMEL)

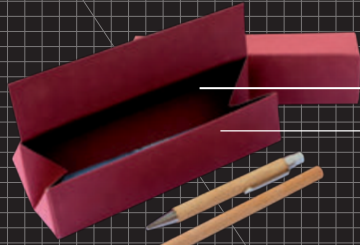

PENS,  
PENCILS  
MAGNET

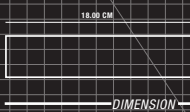

### Z BOX 4 x 21

USE IT CREATIVELY !

- ZNS017-01  
Z BOX 4X21 (BLACK)
- ZNS017-02  
Z BOX 4X21 (GREY)
- ZNS017-03  
Z BOX 4X21 (MINT)
- ZNS017-04  
Z BOX 4X21 (RED)
- ZNS017-05  
Z BOX 4X21 (NAVY BLUE)
- ZNS017-06  
Z BOX 4X21 (CARMEL)

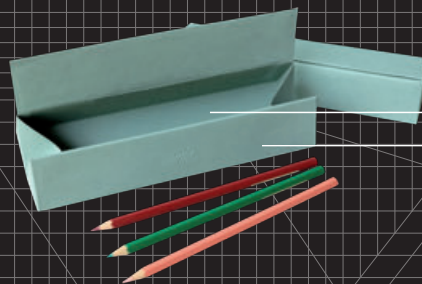

COLOR  
PENCILS  
MAGNET

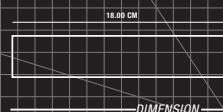

### Z BOX 5 x 15

USE IT CREATIVELY !

- ZNS018-01  
Z BOX 5X15 (BLACK)
- ZNS018-02  
Z BOX 5X15 (GREY)
- ZNS018-03  
Z BOX 5X15 (MINT)
- ZNS018-04  
Z BOX 5X15 (RED)
- ZNS018-05  
Z BOX 5X15 (NAVY BLUE)
- ZNS018-06  
Z BOX 5X15 (CARMEL)



EYEGLASSES  
MAGNET

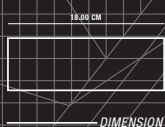

## Z SERIES AND AWARD

- Z WALLET, Z TRAVEL CASE, Z FOLDER WERE AWARDED FROM DEMARK AWARD AND GOOD DESIGN AWARD IN 2015



- Z NOTE WAS AWARDED BY DEMARK AWARD IN 2016



- Z BOX WAS AWARDED BY DEMARK AWARD AND GOOD DESIGN AWARD IN 2017



THE WINNING PRODUCT RECEIVES THE DEMARK LOGO FOR OUTSTANDING DESIGN, WHICH CAN BE USED TO PROMOTE WELL-DESIGNED THAI PRODUCTS IN THE INTERNATIONAL MARKET. IT IS HOPED THAT THIS AWARD WILL HELP PROMOTE DEVELOPMENT OF DOMESTIC PRODUCTS, WHICH WILL IN TURN BETTER THE QUALITY OF LIFE OF BOTH DOMESTIC AND INTERNATIONAL CONSUMERS.



ZONN IS FRESH, FUN, AND TWISTED!  
LET'S ZONN! EXPLORE AND SHARE YOUR EXPERIENCE WITH US!  
SHOW EVERYONE THAT SOMETHING NEW IS HAPPENING.

[WWW.FACEBOOK.COM/ZONN](http://WWW.FACEBOOK.COM/ZONN)  
[WWW.LABRADORFACTORY.NET](http://WWW.LABRADORFACTORY.NET)

